

Report for IMPRESS DSMB: Prepared Dec 2011

Part A: Number of Patients Included and Excluded

There have been 80 patients enrolled in IMPRESS as of Dec 01, 2011. Target enrollment is 160 patients.

Figure 1 presents the overall study status.

Figure 2 shows the cumulative enrollment of patients by month.

Table 1 presents the recruitment in the 29 centers who are participating in IMPRESS, and a month by month picture of the recruitment each center has achieved.

Part B: Summary of patient randomization

Table 2 presents the number of patients by fracture type and treatment assignment. 44 patients were randomized to Treatment A and 36 to Treatment B. Of the 28 open fractures, 14 were randomized to Treatment A (50%) and 14 to Treatment B (50%). Of the 52 closed fractures, 30 were randomized to Treatment A (57.7%) and 22 to Treatment B (42.31%). No patients were found to have crossed over from one treatment arm to the other.

Part C: Patients lost to follow-up, withdrew consent, ineligible

Table 3 shows the patients with early study exits. So far, 17 of the 80 patients enrolled have exited the study early (21.25%). 14 patients have been lost to follow-up (17.5 %) and 1 patient died from injuries unrelated to the research study or device (1.25%). 2 patient voluntarily withdrew consent. 3 patients were randomized but were not enrolled due to discovery of an ineligible fracture patterns and were removed from the study.

Part D: Summary of Adverse Events

Table 4a shows the event rates as of Dec 1, 2011. There have been 15 reported Adverse Events in 12 subjects resulting in a 15.5 percent AE rate in Treatment A, and a 13.89 percent AE rate for Treatment B. Of all 15 events, 6 were definitely not related to the device, 7 were possibly related, and 1 was probably not related and 1 was unknown. 6 of the events were mild, 6 events were moderate, and 3 of the events were considered serious. Of the serious events, 2 were definitely not related to the treatment and the other was probably not related to the treatment.

Table 4b contains the descriptions of the reported Adverse Events

Figure 1: Overall study status

Overall Study Status

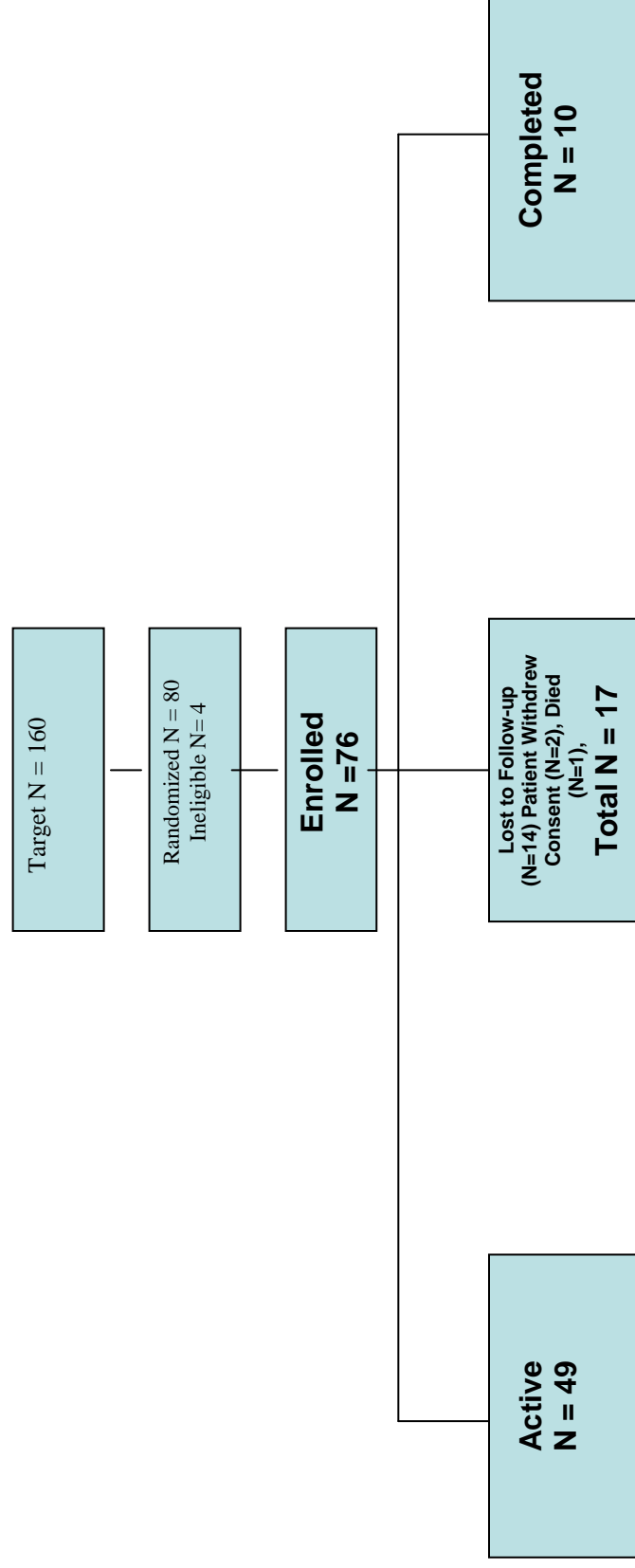

Figure 2: Cumulative enrollment by month:

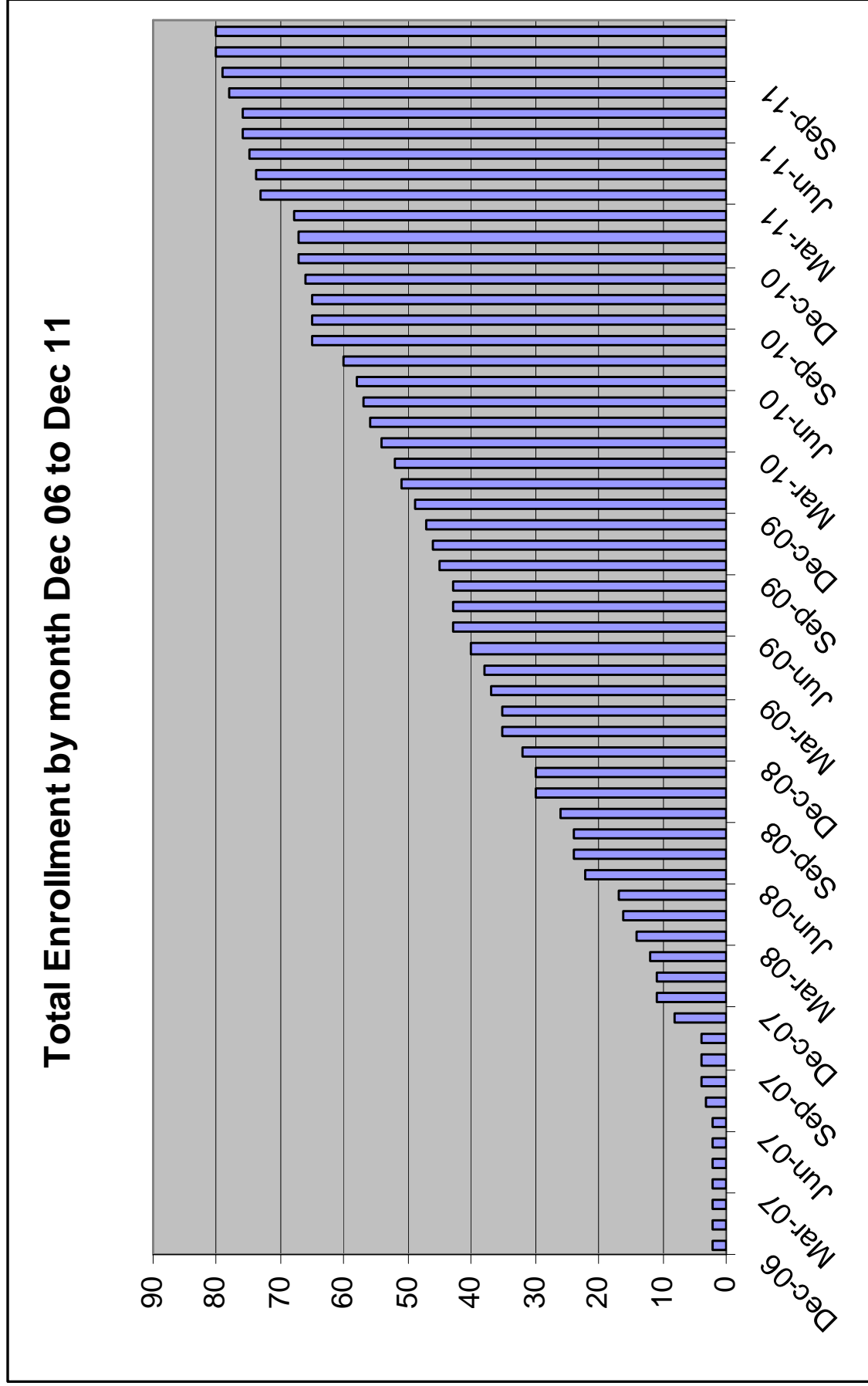

Table 1: Enrollment by Site, Dec. 2006 through November 2009:

Site #	IRB															
	Date	Dec-06	Jan-07	Feb-07	Mar-07	Apr-07	May-07	Jun-07	Jul-07	Aug-07	Sep-07	Oct-07	Nov-07	Dec-07	Jan-08	Feb-08
01	May-07	X	X	X	X	X	X	X	X	X	X	X	X	X	X	X
02	Dec-06	0	0	0	0	0	0	0	0	0	0	0	0	0	0	0
03	Oct-06	0	0	0	0	0	0	0	0	0	0	0	0	0	0	0
04	May-07	X	X	X	X	X	X	X	X	X	X	X	X	X	X	X
05	May-07	X	X	X	X	X	X	X	X	X	X	X	X	X	X	X
06	Nov-06	0	0	0	0	0	0	0	0	0	0	0	1	0	0	0
07	Mar-07	X	X	X	X	X	X	X	X	X	X	X	X	X	X	X
08	Jun-07	X	X	X	X	X	X	X	X	X	X	X	X	X	X	X
09	Apr-07	X	X	X	X	X	X	X	X	X	X	X	X	X	X	X
10	Nov-06	0	0	0	0	0	0	0	0	0	0	0	0	0	0	0
11	Mar-08	X	X	X	X	X	X	X	X	X	X	X	X	X	X	X
12	May-08	X	X	X	X	X	X	X	X	X	X	X	X	X	X	X
13	May-08	X	X	X	X	X	X	X	X	X	X	X	X	X	X	X
14	Jul-07	X	X	X	X	X	X	X	X	X	X	X	X	X	X	X
15	Dec-06	0	0	0	0	0	0	0	0	0	0	0	0	0	0	0
16	Feb-07	X	X	X	X	X	X	X	X	X	X	X	X	X	X	X
17	Dec-06	2	0	0	0	0	0	0	0	0	0	0	1	0	0	0
18	Mar-08	X	X	X	X	X	X	X	X	X	X	X	X	X	X	X
19	May-07	X	X	X	X	X	X	X	X	X	X	X	X	X	X	X
20	Mar-07	X	X	X	X	X	X	X	X	X	X	X	X	X	X	X
21	May-07	X	X	X	X	X	X	X	X	X	X	X	X	X	X	X
22	May-07	X	X	X	X	X	X	X	X	X	X	X	X	X	X	X
23	Jun-08	X	X	X	X	X	X	X	X	X	X	X	X	X	X	X
24	May-09	X	X	X	X	X	X	X	X	X	X	X	X	X	X	X
25	Jun-07	X	X	X	X	X	X	X	X	X	X	X	X	X	X	X
26	Apr-07	X	X	X	X	X	X	X	X	X	X	X	X	X	X	X
27	Jul-07	X	X	X	X	X	X	X	X	X	X	X	X	X	X	X
28	Nov-06	0	0	0	0	0	0	0	0	0	0	0	0	0	0	0
29	Jan-09	X	X	X	X	X	X	X	X	X	X	X	X	X	X	X
30	Apr-07	X	X	X	X	X	X	X	X	X	X	X	X	X	X	X
31	Dec-07	X	X	X	X	X	X	X	X	X	X	X	X	X	X	X
Enrolled		2	0	0	0	0	0	0	1	1	0	0	4	3	0	1
Cumulative		2	2	2	2	2	2	2	3	4	4	4	8	11	11	12
Total Sites		7	7	7	8	13	18	21	23	23	23	23	23	24	24	24

Table 1 continued:

IRB		Mar-08	Apr-08	May-08	Jun-08	Jul-08	Aug-08	Sep-08	Oct-08	Nov-08	Dec-08	Jan-09	Feb-09	Mar-09	Apr-09	May-09
Site #	Date															
01	May-07	1	1	0	0	0	0	0	0	0	0	0	0	0	0	0
02	Dec-06	0	0	0	0	0	0	0	0	0	0	0	0	0	0	0
03	Oct-06	0	0	0	0	0	0	0	0	0	0	0	0	0	0	0
04	May-07	0	0	0	0	0	0	0	0	0	0	0	0	0	0	0
05	May-07	0	0	0	0	0	0	0	0	0	0	0	0	0	0	0
06	Nov-06	0	0	0	0	0	0	0	0	0	0	0	0	0	0	0
07	Mar-07	0	0	0	0	0	0	0	0	0	0	0	0	0	0	0
08	Jun-07	1	0	0	0	1	0	0	0	0	0	0	0	0	0	0
09	Apr-07	0	0	0	0	0	0	0	0	0	0	0	0	0	0	0
10	Nov-06	0	0	0	0	0	0	0	0	0	0	1	0	0	0	0
11	Mar-08	0	0	0	0	0	0	0	0	0	0	0	0	0	0	0
12	May-08	X	X	0	0	0	0	0	0	0	0	0	0	1	0	0
13	May-08	X	X	0	0	0	0	0	0	0	0	0	0	0	0	0
14	Jul-07	X	X	0	0	0	0	0	0	0	0	0	0	0	0	0
15	Dec-06	0	0	0	1	0	0	1	1	0	0	0	0	1	0	1
16	Feb-07	0	0	0	0	0	0	0	0	0	0	0	0	0	0	0
17	Dec-06	0	0	0	2	0	0	0	0	0	1	1	0	0	0	0
18	Mar-08	0	0	0	2	0	0	1	0	0	0	0	0	0	0	1
19	May-07	0	0	0	0	0	0	0	0	0	0	0	0	0	0	0
20	May-07	0	0	0	0	0	0	0	1	0	0	0	0	0	0	0
21	May-07	0	0	0	0	1	0	0	1	0	0	0	0	0	0	0
22	May-07	0	0	0	0	0	0	0	0	0	0	0	0	0	0	0
23	Jun-08	X	X	0	0	0	0	0	0	0	0	0	0	0	0	0
24	May-09	X	X	X	X	X	X	X	X	X	X	X	X	X	X	0
25	Jun-07	0	0	0	0	0	0	0	0	0	0	0	0	0	0	0
26	Apr-07	0	0	0	0	0	0	0	0	0	0	1	0	0	1	0
27	Jul-07	0	1	0	0	0	0	0	0	0	0	0	0	0	0	0
28	Nov-06	0	0	0	0	0	0	0	0	0	0	0	0	0	0	0
29	Jan-09	X	X	X	X	X	X	X	X	X	X	0	0	0	0	0
30	Apr-07	0	0	0	0	0	0	0	1	0	0	0	0	0	0	0
31	Dec-07	0	0	0	0	0	0	0	0	0	0	0	0	0	0	0
Enrolled		2	2	1	5	2	0	2	4	0	2	3	0	2	1	2
Cumulative		14	16	17	22	24	24	26	30	30	32	35	35	37	38	40
Total Sites		27	27	29	29	29	29	29	29	29	29	30	30	30	30	31

Table 1 Continued

Site #	IRB Date	Jun-09	Jul-09	Aug-09	Sep-09	Oct-09	Nov-09	Dec-09	Jan-10	Feb-10	Mar-10	Apr-10	May-10	Jun-10	Jul-10	Aug-10
01	May-07	0	0	0	0	0	0	0	0	0	0	0	0	0	0	0
02	Dec-06	0	0	0	0	0	0	0	0	0	0	0	0	0	0	0
03	Oct-06	0	0	0	0	0	0	0	0	0	0	0	0	0	0	0
04	May-07	0	0	0	0	0	0	X	X	X	X	X	X	X	X	X
05	May-07	0	0	0	0	0	0	0	0	0	0	0	0	0	0	0
06	Nov-06	0	0	0	0	0	1	0	0	0	0	0	0	0	0	1
07	Mar-07	0	0	0	0	0	0	0	0	0	0	0	0	0	0	0
08	Jun-07	0	0	0	0	0	0	0	0	0	1	0	0	0	0	0
09	Apr-07	0	0	0	0	0	0	0	0	X	X	X	X	X	X	X
10	Nov-06	0	0	0	0	0	0	0	0	0	0	0	0	0	0	0
11	Mar-08	0	0	0	0	0	0	0	0	0	0	0	0	0	0	1
12	May-08	1	0	0	0	0	0	1	0	0	1	1	0	0	1	0
13	May-08	0	0	0	0	0	0	0	X	X	X	X	X	X	X	X
14	Jul-07	0	0	0	0	0	0	0	0	0	0	0	0	0	0	0
15	Dec-06	0	0	0	1	0	0	1	1	0	0	1	0	0	0	0
16	Feb-07	0	0	0	0	0	0	0	0	0	0	0	0	0	0	0
17	Dec-06	1	0	0	0	1	0	0	0	0	0	0	0	0	0	0
18	Mar-08	1	0	0	1	0	0	0	1	0	0	0	0	0	1	0
19	May-07	0	0	0	0	0	0	0	0	0	0	0	0	0	0	0
20	Mar-07	0	0	0	0	0	0	0	0	0	0	0	0	0	0	0
21	May-07	0	0	0	0	0	0	0	0	0	0	0	1	0	0	2
22	May-07	0	0	0	0	0	0	0	0	0	0	0	0	0	0	0
23	Jun-08	0	0	0	0	0	0	0	0	1	0	0	0	0	0	0
24	May-09	0	0	0	0	0	0	0	0	0	0	0	0	0	0	0
25	Jun-07	0	0	0	0	0	0	0	0	0	0	0	0	0	0	0
26	Apr-07	0	0	0	0	0	0	0	0	0	0	0	0	0	0	0
27	Jul-07	0	0	0	0	0	0	0	0	0	0	0	0	0	0	0
28	Nov-06	0	0	0	0	0	0	0	0	0	0	0	0	0	0	0
29	Jan-09	0	0	0	0	0	0	0	0	0	0	0	0	0	0	0
30	Apr-07	0	0	0	0	0	0	0	0	0	0	0	0	1	0	1
31	Dec-07	0	0	0	0	0	0	0	0	0	0	0	0	0	0	0
32	Aug-10	X	X	X	X	X	X	X	X	X	X	X	X	X	X	X
Enrolled		3	0	0	2	1	1	2	2	1	2	2	1	1	2	5
Cumulative		43	43	43	45	46	47	49	51	52	54	56	57	58	60	65
Total Sites		31	31	31	31	31	31	30	29	28	28	28	28	28	28	29

Table 1 Continued

Site #	IRB Date	10-Sep	10-Oct	10-Nov	10-Dec	11-Jan	11-Feb	11-Mar	11-Apr	11-May	11-Jun
1	7-May	0	0	0	0	0	0	0	0	0	0
2	6-Dec	0	0	0	0	0	0	0	0	0	0
3	6-Oct	0	0	0	0	0	0	1	0	0	0
4	7-May	X	X	X	X	X	X	X	X	X	X
5	7-May	0	0	0	0	0	0	0	0	0	0
6	6-Nov	0	0	0	0	0	0	0	0	0	0
7	7-Mar	0	0	0	0	0	0	0	0	0	0
8	7-Jun	0	0	0	0	0	0	0	0	0	0
9	7-Apr	X	X	X	X	X	X	X	X	X	X
10	6-Nov	0	0	0	0	0	0	0	0	0	0
11	8-Mar	0	0	0	0	0	0	0	0	0	0
12	8-May	0	0	0	1	0	0	1	0	0	0
13	8-May	X	X	X	X	X	X	X	X	X	X
14	7-Jul	0	0	0	0	0	0	1	0	0	0
15	6-Dec	0	0	0	0	0	0	0	1	1	0
16	7-Feb	0	0	0	0	0	0	0	0	0	0
17	Dec-06	0	0	0	0	0	1	2	0	0	0
18	8-Mar	0	0	0	0	0	0	0	0	0	0
19	7-May	0	0	0	0	0	0	0	0	0	0
20	7-Mar	0	0	0	0	0	0	0	0	0	0
21	7-May	0	0	0	0	0	0	0	0	0	0
22	7-May	0	0	0	0	0	0	0	0	0	0
23	8-Jun	0	0	0	0	0	0	0	0	0	0
24	9-May	0	0	0	0	0	0	0	0	0	0
25	7-Jun	0	0	0	0	0	0	0	0	0	0
26	7-Apr	0	0	0	0	0	0	0	0	0	0
27	7-Jul	0	0	0	0	0	0	0	0	0	0
28	6-Nov	0	0	0	0	0	0	0	0	0	0
29	9-Jan	0	0	0	0	0	0	0	0	0	0
30	7-Apr	0	0	1	0	0	0	0	0	0	0
31	7-Dec	0	0	0	0	0	0	0	0	0	0
32	10-Aug	0	0	0	0	0	0	0	0	0	1
Enrolled		0	0	1	1	0	1	5	1	1	1
Cumulative		65	65	66	67	67	68	73	74	75	76
Total Sites		29	29	29	29	29	29	29	29	29	29

Site #	IRB Date	11-Jul	11-Aug	11-Sep	11-Oct	11-Nov
1	7-May	0	0	0	0	0
2	6-Dec	0	0	0	0	0
3	6-Oct	0	0	0	0	0
4	7-May	X	X	X	X	X
5	7-May	0	0	0	0	0
6	6-Nov	0	0	0	0	0
7	7-Mar	0	0	0	0	0
8	7-Jun	0	0	0	0	0
9	7-Apr	X	X	X	X	X
10	6-Nov	0	0	0	0	0
11	8-Mar	0	0	0	0	0
12	8-May	0	0	1	0	0
13	8-May	X	X	X	X	X
14	7-Jul	0	0	0	0	0
15	6-Dec	0	1	0	1	0
16	7-Feb	0	0	0	0	0
17	Dec-06	0	0	0	0	0
18	8-Mar	0	1	0	0	0
19	7-May	0	0	0	0	0
20	7-Mar	0	0	0	0	0
21	7-May	0	0	0	0	0
22	7-May	0	0	0	0	0
23	8-Jun	0	0	0	0	0
24	9-May	0	0	0	0	0
25	7-Jun	0	0	0	0	0
26	7-Apr	0	0	0	0	0
27	7-Jul	0	0	0	0	0
28	6-Nov	0	0	0	0	0
29	9-Jan	0	0	0	0	0
30	7-Apr	0	0	0	0	0
31	7-Dec	0	0	0	0	0
32	10-Aug	0	0	0	0	0
Enrolled		0	2	1	1	0
Cumulative		76	78	79	80	80
Total Sites		29	29	29	29	29

Part B: Summary of patient randomization

Table 2: Enrollment by Fracture Type and Treatment Assignment:

Site #	Treatment A			Treatment B			Total		
	Open	Closed	Total	Open	Closed	Total	Open	Closed	Total
1	0	1	1	0	1	1	0	2	2
2	0	0	0	0	0	0	0	0	0
3	0	0	0	0	1	1	0	1	1
4	0	0	0	0	0	0	0	0	0
5	0	0	0	0	0	0	0	0	0
6	0	2	2	0	1	1	0	3	3
7	0	0	0	0	0	0	0	0	0
8	2	0	2	1	0	1	3	0	3
9	0	0	0	0	0	0	0	0	0
10	0	1	1	0	0	0	0	1	1
11	0	0	0	0	0	0	0	0	0
12	0	6	6	0	5	5	0	11	11
13	0	0	0	0	0	0	0	0	0
14	0	1	1	0	1	1	0	2	2
15	3	4	7	4	3	7	7	7	14
16	0	1	1	0	0	0	0	1	1
17	1	7	8	2	4	6	3	11	14
18	2	1	3	2	3	5	4	3	7
19	0	0	0	0	0	0	0	0	0
20	0	1	1	0	0	0	0	1	1
21	2	2	4	1	0	1	3	2	5
22	0	0	0	1	1	2	1	1	2
23	0	0	0	1	0	1	1	0	1
24	0	0	0	0	0	0	0	0	0
25	0	0	0	0	0	0	0	0	0
26	1	1	2	1	0	1	2	1	3
27	1	2	3	0	1	1	1	3	4
28	0	0	0	0	0	0	0	0	0
29	0	0	0	0	0	0	0	0	0
30	2	1	3	1	0	1	3	1	4
31	0	0	0	0	0	0	0	0	0
32	0	0	0	0	1	1	0	1	1
TOTAL	14	30	44	14	22	36	28	52	80

Part C: Patients lost to follow-up, withdrew consent, ineligible

Table 3: Patients lost to follow-up, withdrew consent, ineligible:

Site #	Pt ID	Date of Enrollment	Date of Last Follow-up	Reason
06	6-01	11/5/2007	1/4/2008	Reason unknown - patient lost to follow-up
10	10-01	1/5/2009	no follow-up	Patient is mentally Impaired and has not been able to comply with F/Us
12	12-01	03/18/2009	06/16/2009	Reason unknown - patient lost to follow-up
15	15-02	6/6/2008	8/5/2008	Reason unknown - patient lost to follow-up
15	15-04	10/31/2008	No follow-up	Reason unknown-patient lost to follow-up.
17	17-03	11/3/2007	no follow-up	Patient moved away
18	18-03	09/21/08	01/08/2009	Homeless and unreachable.
20	20-01	10/23/2008	-	Patient withdrawn (by study team)
21	21-01	7/29/2008	-	Patient withdrew consent.
26	26-01	7/11/2007	no follow-up	Reason unknown - patient lost to follow-up
26	26-02	1/20/2009	-	Patient withdrawn (by study team)
27	27-01	11/20/2007	1/3/2008	Reason unknown - patient lost to follow-up
27	27-02	12/28/2007	no follow-up	Reason unknown - patient lost to follow-up
27	27-03	2/10/2008	6/30/2008	Reason unknown - patient lost to follow-up
27	27-04	4/6/2008	no follow-up	Reason unknown - patient lost to follow-up
18	18-02	06/25/2008	01/08/2009	Reason unknown - patient lost to follow-up
30	30-01	10/20/2008	-	Patient deceased

Part D: Summary of Adverse Events

Table 4a: Adverse Event rates by treatment and fracture type:

	Total Events	Total Patients w/ Events	Enrollment (Adverse Event Rate%)
Treatment A	10	7	45 (15.5)
Open	2	2	14 (14.3)
Closed	8	5	31 (16.13)
Treatment B	5	5	36 (13.89)
Open	3	3	14(21.4)
Closed	2	2	22 (9.09)
Total	15	12	80(15.0)
Open	5	5	28 (17.8)
Closed	10	7	59 (11.86)

Table 4b: Adverse Event descriptions:

Site #	Patient ID	Treatment	Fx Type	AE Date	Related	Severity	Expected	Description
1	1-Jan	A	CLOSED	5/23/2008	Possibly	Mod	NO	30 DEGREE APEX ANTERIOR ANGULATION NOTED ON XRAY - R TIBIA
1	1-Jan	A	CLOSED	9/15/2008	Def Not	Mod	NO	INFECTION - DEEP
1	1-Jan	A	CLOSED	6/23/2009	Def Not	Mod	NO	WOUND BREAKDOWN RIGHT PROXIMAL TIBIA SURGICAL SITE.
17	17-01	A	CLOSED	11/6/2007	Possibly	Mild	NO	PAINFUL IMPLANT - SCREW
12	3-Dec	A	CLOSED	6/24/2010	Likely	Mild	NO	PAINFUL IMPLANT: SCREW
30	30-04	A	CLOSED	11/3/2010	Possibly	Mild	NO	Compartment Syndrome
18	18-05	A	OPEN	4/8/2010	Possibly	Mild	NO	NON-UNION
30	30-01	A	OPEN	10/28/2008	Def Not	Sev	NO	MULTITRAUMA/STROKE/INTRACRANIAL HYPERTENSION
15	15-11	A	CLOSED	6/14/2011	Possible	Mod	NO	OSTEOTOMY,MALUNION REPAIR,NAIL REMOVAL,PLATE PLACEMENT.
15	15-11	A	CLOSED	7/24/2011	DEF NOT	Mod	NO	DEEP INFECTION.
1	2-Jan	B	CLOSED	4/19/2008	Def Not	Sev	NO	ASPIRATION PNEUMONIA
15	15-03	B	CLOSED	3/24/2009	Possibly	Mild	NO	NON-UNION
26	26-03	B	OPEN	6/3/2009	Unknown	Mild	NO	INFECTION – SUPERFICIAL
21	21-004	B	OPEN	6/22/2011	Def Not	Sev	NO	Non displaced Dist.Fibula Fx.
18	18-07	B	OPEN	9/7/2010	Possibly	Mod	NO	Wound healing difficulty

